

Tommy Car Wash Systems

Accent Lighting Guide

(Internal Use Only)

Prepared by:

A+ Lighting Solutions

Version 1.0

May 15, 2025

TABLE OF CONTENTS

(Internal Use Only)	0
1. INTRODUCTION	2
1.1 Purpose of this Guide	2
1.2 Scope and Limitations	2
2. Design Intent	3
2.1 Accent Lighting Vision	3
2.2 Application Philosophy	3
3. Product Information	5
3.1 Product Overview	5
Core Product Specs - See Appendix D for Spec Sheets and Installation Manuals	5
3.2 Bending Types and Mounting	6
3.3 Additional System Components	7
4. System Architecture	8
4.1 Building Types and Kit Priorities	8
4.2 Standard Model Kit Composition Chart	9
4.3 Flex Model Kit Composition Chart	10
5. Installation Standards	11
5.1 Key Installation Principles	11
Note: All installation instructions for Diode LED components are available in Appendix D.	
11	
5.2 Mounting Requirements	11
5.3 Project Planning and Field Coordination	11
5.4 Handling and Damage Precautions	11
6. Kit Management	12
6.1 Kit Identification and Packaging	12
6.2 Kit Reference Drawings	13
7. Appendices	14
7.1 Appendix A: Standard Model Accent Lighting Plan	14
7.2 Appendix B: Flex Model Accent Lighting Plan	16
7.3 Appendix C: Voltage Drop Chart	17
7.4 Appendix D: Product Specification Sheets	18
7.5 Appendix E: Product Installation Manuals	29

1. INTRODUCTION

1.1 Purpose of this Guide

This manual provides a comprehensive overview of the **Tommy's Express Car Wash Accent Lighting Package**, with design intents, detailed product information, kit component breakdowns, packaging descriptions, installation standards, and project planning guidelines.

It is intended **specifically for Tommy's internal teams** — including Project Managers, Engineering, Construction Management, and other corporate staff involved in building rollout, coordination, or support.

Note: A simplified version of this guide is available separately for installing contractors and electricians, covering only field-relevant steps.

1.2 Scope and Limitations

This manual covers:

- Accent lighting kits for **Standard** and **Flex** site models.
- Usage of factory-assembled **Diode LED Neon Blaze** systems (4000K).
- Standard installation methods and critical project coordination practices.

This guide does **not** replace construction drawings, architectural plans, or engineered electrical layouts. Any field modifications or deviations must be approved by **Tommy's Engineering Team**.

2. Design Intent

2.1 Accent Lighting Vision

The accent lighting package is designed to elevate Tommy's Express Car Wash brand image by providing clean, vibrant, direct-view lighting at key architectural features, creating a strong nighttime identity. Accent lighting is intended primarily for aesthetic purposes—to make the architectural features of the building visible from great distances at night—and is not intended to provide additional usable light for site safety, pedestrian traffic, or wayfinding.

The only exception is the "sunburst" lighting around the entry and exit doors, which is designed to be both direct-view and to illuminate the "sunburst" architectural feature on the wall.

2.2 Application Philosophy

Accent lighting is to be highly visible, uniform, and seamlessly integrated into the building architecture. Due to the prominent visibility of the lighting elements, the utmost care is required in installation to ensure a clean and professional appearance.

Installations must prioritize:

- **Straight, Precise Lines:** Lighting must follow architectural features exactly, maintaining consistent spacing and alignment.
- **Proper Centering and Placement:** Fixtures must be accurately positioned to match intended design references.
- **Consistency:** Installations must match the standard design intent across all locations, avoiding improvisation or unapproved deviations.
- **Reliability:** All connections, penetrations, and mounting methods must be properly secured and protected against weather, vibration, and mechanical stress.

Important: No field adjustments are permitted unless reviewed and approved by Tommy's Engineering Team. Additionally, the accent lighting package is not guaranteed to meet the specific requirements of local building or lighting ordinances; it is the responsibility of the local project team to verify compliance with any applicable codes.

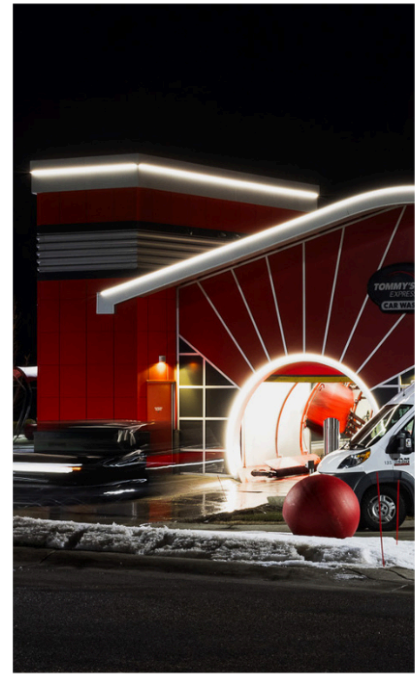

3. Product Information

3.1 Product Overview

The Tommy's Express Accent Lighting Package is built around the **Neon Blaze Series** from **Diode LED**, a premium U.S.-based manufacturer specializing in LED tape, accent, and architectural lighting solutions.

Diode LED delivers highly reliable, **specification-grade products** known for:

- Excellent consistency in light color and quality
- Wide range of bending, mounting, and connection options
- Robust, field-proven designs for harsh exterior conditions
- UL listed, 5-year warranty, factory-tested assemblies

The Neon Blaze system selected for Tommy's sites provides **smooth, dot-free illumination**, visible from great distances, while maintaining flexibility for installation along building curves and lines.

Core Product Specs - See *Appendix D for Spec Sheets and Installation Manuals*

- **Series:** Diode LED Neon Blaze
- **Color Temperature:** 4000K
- **Voltage:** 24V DC
- **Construction:** Flexible Silicone Encapsulation
- **Protection Rating:** IP67 (outdoor rated).* Only factory-finished product with sealed terminations meets this rating.
- **Output Options:**
 - **Low Output (NBL1)** – 1.22W/ft. Used on tower accents and eyebrows.
 - **Mid Output (NBL2)** – 2.44W/ft. Used on sunburst entry/exit rings where higher illumination is desired.

✓ *No field modification allowed: all lighting runs are factory cut, terminated, and prewired to preserve warranty and performance.*

3.2 Bending Types and Mounting

Top Bending (Towers, Sunbursts): Bends upward/downward to follow vertical shapes.

Top bending NEON BLAZE™ LED Strip Light may be bent "up and down" on the vertical axis of the Strip Light.

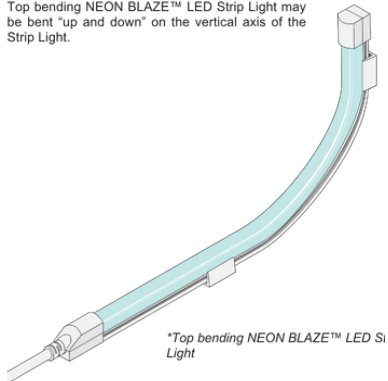

NEON BLAZE™ Top bending
Flexible Channel
DI-TE-NB-FLCH-WH

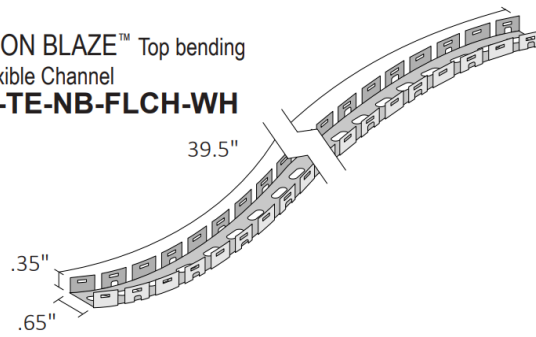

Side Bending (Eyebrows): Bends left/right to follow rooflines and curved architectural features.

Side bending NEON BLAZE™ LED Strip Light may be bent "Left and Right" on the horizontal axis of the Strip Light.

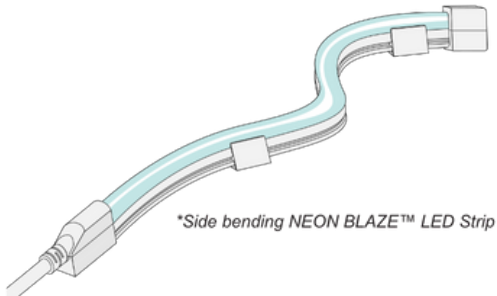

NEON BLAZE™ Side bending
Flexible Channel
DI-SE-NB-FLCH-WH

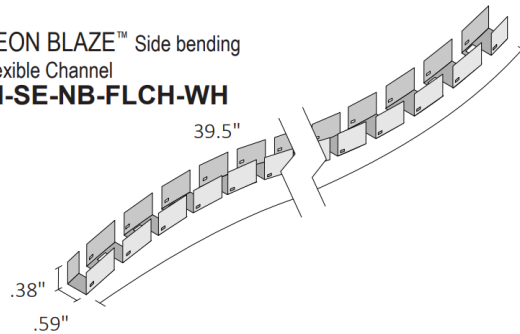

Flexible Spine Mounting Channel (DI-TE/SE-NB-FLCH-WH)

- Provided in standard 39" lengths
- Low-profile design intended for straight, surface-mounted installation
- To be mechanically fastened to the structure using installer-supplied anchors

3.3 Additional System Components

This lighting system includes a small number of core components, all factory-specified and integrated into each lighting kit:

96W OMNIDRIVE X Driver (DI-ODX-24V96W-J)

- Input: 120–277V AC
- Output: 24V DC constant voltage
- Integrated J-box for hardwired connection
- ELV and 0–10V dimming capability **Not used at this time*

20 ft Low Voltage Leader Cable (Factory-attached)

- UL-listed, sealed 2-conductor cable
- Connects LED run to driver location inside structure

IP67 Rated Jumpers

- Used to bridge multiple factory-assembled segments
- Supplied only where necessary - Tower runs only
- First piece ends with 4in Male Connector, second piece starts with 4in Female Connector

Sealant and End Caps

- Factory-installed with IP67 heat seal to ensure water-tight rating



All accessories and low-voltage terminations are sealed at the factory. No field wiring or substitution is allowed.

4. System Architecture

4.1 Building Types and Kit Priorities

- **Standard Model:** 2 Sunbursts, 4 Tower runs, 2 Eyebrow runs.
- **Flex Model:** 6 Sunbursts, 4 Tower runs, extended Eyebrow runs.
- **World Model:** Concept site only; not part of rollout focus.

Primary focus remains on **Standard Models** for 2024–2025 deployments.

4.2 Standard Model Kit Composition Chart

The following table summarizes the Diode LED components, A+ kit numbers, and corresponding Tommy part numbers for each lighting run on a Standard Model site.

Accent Lighting Kit Composition Chart						Standard Site	
Run Name	Location	Type	Tommy Part #	A+ Kit Part #	DiodeLED Components	Qty / Standard Site	
Sunburst	Entry & Exit Doors, On Outside of Ring	N1	P-LED-ACC-SUNBURST	TCWS-ACCENT-SUNBURST-4K	(1) DI-SO-24V-TE-NBL1-40K-27.14F-STE-20FBW-IP67 (9) DI-TE-NB-FLCH-WH (1) DI-ODX-24V96W-J	2	
Eyebrow	Entry & Exit Roofline, On Face of Eyebrow	N2	P-LED-ACC-EYEBROW	TCWS-ACCENT-EYEBROW-4K	(1) DI-SO-24V-SE-NBL1-40K-38.95F-STE-20FBW-IP67 (12) DI-SE-NB-FLCH-WH (1) DI-ODX-24V96W-J	2	
Tower A - Run 1	Wash-side and Curved Front of Tower A	N3	P-LED-ACC-TOWER-A-R1	TCWS-ACCENT-TOWER-A-R1-4K	(1) DI-SO-24V-TE-NBL1-40K-15.17F-STE-20FBW-4IMIP67-IP67 (1) DI-SO-24V-TE-NBL1-40K-32.55F-STE-4IFIP67-IP67 (15) DI-TE-NB-FLCH-WH (1) DI-ODX-24V96W-J	1	
Tower A - Run 2	Flat Back and Wash Entry Sides of Tower A	N4	P-LED-ACC-TOWER-A-R2	TCWS-ACCENT-TOWER-A-R2-4K	(1) DI-SO-24V-TE-NBL1-40K-32.06F-STE-20FBW-4IMIP67-IP67 (1) DI-SO-24V-TE-NBL1-40K-15.17F-STE-4IFIP67-IP67 (15) DI-TE-NB-FLCH-WH (1) DI-ODX-24V96W-J	1	
Tower B - Run 1	Wash-side and Curved Front of Tower B	N5	P-LED-ACC-TOWER-B-R1	TCWS-ACCENT-TOWER-B-R1-4K	(1) DI-SO-24V-TE-NBL1-40K-9.59F-STE-20FBW-4IMIP67-IP67 (12) DI-TE-NB-FLCH-WH (1) DI-ODX-24V96W-J	1	
Tower B - Run 2	Flat Back and Wash Entry Sides of Tower B	N6	P-LED-ACC-TOWER-B-R2	TCWS-ACCENT-TOWER-B-R2-4K	(1) DI-SO-24V-TE-NBL1-40K-26.81F-STE-20FBW-4IMIP67-IP67 (1) DI-SO-24V-TE-NBL1-40K-9.59F-STE-4IFIP67-IP67 (12) DI-TE-NB-FLCH-WH (1) DI-ODX-24V96W-J	1	

4.3 Flex Model Kit Composition Chart

The following table summarizes the Diode LED components, A+ kit numbers, and corresponding Tommy part numbers for each lighting run on a Flex Model site.

Run Name	Location	Type	Tommy Part #	A+ Kit Part #	DiodeLED Components	Qty / Flex Site
Sunburst	Entry & Exit Doors, On Outside of Ring	N1	P-LED-ACC-SUNBURST	TCWS-ACCENT-SUNBURST-4K	(1) DI-SO-24V-TE-NBL1-40K-27-14F-STE-20FBW-IP67 (9) DI-TE-NB-FLCH-WH (1) DI-ODX-24V98W-J	6
Entry Eyebrow	Entry Eyebrow - Single continuous roofline lit with (2) runs, fed from ends, meet in middle	?	?	TCWS-ACCENT-ENTRYEYEBROW-FLX-4K	(1) DI-SO-24V-SE-NBL1-40K-49-29F-STE-20FBW-IP67 (3) DI-SE-NB-FLCH-WH (2) DI-ODX-24V98W-J	1
Exit Eyebrow	Exit Eyebrow - Roofline split by tower, (2) separate runs	?	?	TCWS-ACCENT-EXITEYEBROW-FLX-4K	(1) DI-SO-24V-SE-NBL1-40K-52-4F-STE-20FBW-IP67 (1) DI-SO-24V-SE-NBL1-40K-37-97F-STE-20FBW-IP67 (28) DI-SE-NB-FLCH-WH (2) DI-ODX-24V98W-J	1
Tower A - Run 1	Wash-side and Curved Front of Tower A	N3	P-LED-ACC-TOWER-A-R1	TCWS-ACCENT-TOWER-A-R1-4K	(1) DI-SO-24V-TE-NBL1-40K-15-17F-STE-20FBW-4MIP67-IP67 (1) DI-SO-24V-TE-NBL1-40K-32-55F-STE-STE-4IFIP67-IP67 (15) DI-TE-NB-FLCH-WH (1) DI-ODX-24V98W-J	1
Tower A - Run 2	Flat Back and Wash Entry Sides of Tower A	N4	P-LED-ACC-TOWER-A-R2	TCWS-ACCENT-TOWER-A-R2-4K	(1) DI-SO-24V-TE-NBL1-40K-32-06F-STE-20FBW-4MIP67-IP67 (1) DI-SO-24V-TE-NBL1-40K-15-17F-STE-4IFIP67-IP67 (15) DI-TE-NB-FLCH-WH (1) DI-ODX-24V98W-J	1
Tower B - Run 1	Wash-side and Curved Front of Tower B	N5	P-LED-ACC-TOWER-B-R1	TCWS-ACCENT-TOWER-B-R1-4K	(1) DI-SO-24V-TE-NBL1-40K-9-59F-STE-20FBW-4MIP67-IP67 (1) DI-SO-24V-TE-NBL1-40K-27-3F-STE-4IFIP67-IP67 (12) DI-TE-NB-FLCH-WH (1) DI-ODX-24V98W-J	1
Tower B - Run 2	Flat Back and Wash Entry Sides of Tower B	N6	P-LED-ACC-TOWER-B-R2	TCWS-ACCENT-TOWER-B-R2-4K	(1) DI-SO-24V-TE-NBL1-40K-26-81F-STE-20FBW-4MIP67-IP67 (1) DI-SO-24V-TE-NBL1-40K-9-59F-STE-4IFIP67-IP67 (12) DI-TE-NB-FLCH-WH (1) DI-ODX-24V98W-J	1

Accent Lighting Kit Composition Chart

Flex Site

5. Installation Standards

5.1 Key Installation Principles

- Eyebrow and tower lighting are direct-view and must face outward.
- Sunburst lighting is mounted to the outer face of the door arch, facing away from the centerline of the door opening.
- No splicing, cutting, or field rewiring allowed.
- Follow published architectural drawings exactly.

Note: All installation instructions for Diode LED components are available in Appendix D.

5.2 Mounting Requirements

- Mounting Channels provided.
- Screws/anchors supplied by installer.
- No adhesives or alternate hardware allowed.

5.3 Project Planning and Field Coordination

- Complete rough-in wiring before drywall or insulation.
- Coordinate with Tommy's Engineering if field conditions change.

5.4 Handling and Damage Precautions

 **Handling Warning:** Tape light must be handled with care. Excessive handling, bending, or applying pressure may damage the product and will void the warranty.

6. Kit Management

6.1 Kit Identification and Packaging

All accent lighting shipments from A+ Lighting are pre-sorted and packaged as **complete installation kits** for each specific architectural run. Each carton is labeled with the corresponding kit identifier and contains only the components necessary for that lighting location.

⚠ Important: Installing contractors must review all instructions and project documentation **before opening any packaging**. Kits should be opened **only when ready to install** that specific run.

Do **not** remove all parts from all cartons upon delivery. This leads to confusion, lost components, misrouted materials, and significant delays. Each kit is designed to be plug-and-play for one specific section of the building, and components are matched exactly to the labeled location.



Each kit includes:

1. Master carton clearly labeled with A+ Lighting kit part number & Tommy PO number
2. Inner carton(s) containing spool of Neon Blaze lighting with factory-assembled connectors
 - o Carton and spool labeled with description of included product
3. Flexible spine channels
4. 96W OMNIDRIVE driver

6.2 Kit Reference Drawings

All Tommy's Express Car Wash buildings using the Accent Lighting Package follow a standardized model. Contractors must reference the **published architectural drawings** for the specific site to determine where each labeled lighting kit should be installed.

 **Important:** Do not rely on guesswork or historical installations. Drawings for each project may contain slight adjustments in feature layout or structure. Always verify lighting locations using the official construction documents.

For questions about product technical features (such as output, part numbers, or included components), contact **A+ Lighting:**

- **Email:** tommy@apluslightingllc.com
- **Phone:** (866) 798-4446

For questions about installation methods, wire routing, penetrations, fastening, or any building-specific guidance, contact the appropriate **Tommy's Project Manager or Engineering Team.**

7. Appendices

7.1 Appendix A: Standard Model Accent Lighting Plan

The example shown on the following page illustrates a Standard Model site with labeled accent lighting features. This drawing is for reference only and does not represent the actual site layout for any given project. Always refer to the published architectural drawings for site-specific information.

- GENERAL SHEET NOTES**
- THE ELECTRICAL CONTRACTOR SHALL BE RESPONSIBLE FOR COORDINATING AND INSTALLING THE LIGHTING SYSTEMS AS SHOWN ON THIS SHEET. ALL WORK SHALL BE IN ACCORDANCE WITH THE NATIONAL ELECTRICAL CODE (NEC) AND ALL APPLICABLE LOCAL, STATE AND FEDERAL REGULATIONS.
 - ALL WORK SHALL BE IN ACCORDANCE WITH THE NATIONAL ELECTRICAL CODE (NEC) AND ALL APPLICABLE LOCAL, STATE AND FEDERAL REGULATIONS.
 - CONDUIT SHALL BE INSTALLED TO PROTECT ALL WIRING FROM PHYSICAL DAMAGE AND TO PROVIDE A NEAT AND PROFESSIONAL APPEARANCE.
 - ALL WIRING SHALL BE INSTALLED IN ACCORDANCE WITH THE NATIONAL ELECTRICAL CODE (NEC) AND ALL APPLICABLE LOCAL, STATE AND FEDERAL REGULATIONS.
 - ALL WORK SHALL BE IN ACCORDANCE WITH THE NATIONAL ELECTRICAL CODE (NEC) AND ALL APPLICABLE LOCAL, STATE AND FEDERAL REGULATIONS.
 - ALL WORK SHALL BE IN ACCORDANCE WITH THE NATIONAL ELECTRICAL CODE (NEC) AND ALL APPLICABLE LOCAL, STATE AND FEDERAL REGULATIONS.
 - ALL WORK SHALL BE IN ACCORDANCE WITH THE NATIONAL ELECTRICAL CODE (NEC) AND ALL APPLICABLE LOCAL, STATE AND FEDERAL REGULATIONS.
 - ALL WORK SHALL BE IN ACCORDANCE WITH THE NATIONAL ELECTRICAL CODE (NEC) AND ALL APPLICABLE LOCAL, STATE AND FEDERAL REGULATIONS.
 - ALL WORK SHALL BE IN ACCORDANCE WITH THE NATIONAL ELECTRICAL CODE (NEC) AND ALL APPLICABLE LOCAL, STATE AND FEDERAL REGULATIONS.
 - ALL WORK SHALL BE IN ACCORDANCE WITH THE NATIONAL ELECTRICAL CODE (NEC) AND ALL APPLICABLE LOCAL, STATE AND FEDERAL REGULATIONS.
- SHEET KEYNOTES**
1. LIGHTING FIXTURES SHALL BE INSTALLED IN ACCORDANCE WITH THE NATIONAL ELECTRICAL CODE (NEC) AND ALL APPLICABLE LOCAL, STATE AND FEDERAL REGULATIONS.
 2. ALL WIRING SHALL BE INSTALLED IN ACCORDANCE WITH THE NATIONAL ELECTRICAL CODE (NEC) AND ALL APPLICABLE LOCAL, STATE AND FEDERAL REGULATIONS.
 3. CONDUIT SHALL BE INSTALLED TO PROTECT ALL WIRING FROM PHYSICAL DAMAGE AND TO PROVIDE A NEAT AND PROFESSIONAL APPEARANCE.
 4. ALL WIRING SHALL BE INSTALLED IN ACCORDANCE WITH THE NATIONAL ELECTRICAL CODE (NEC) AND ALL APPLICABLE LOCAL, STATE AND FEDERAL REGULATIONS.
 5. ALL WORK SHALL BE IN ACCORDANCE WITH THE NATIONAL ELECTRICAL CODE (NEC) AND ALL APPLICABLE LOCAL, STATE AND FEDERAL REGULATIONS.
 6. ALL WORK SHALL BE IN ACCORDANCE WITH THE NATIONAL ELECTRICAL CODE (NEC) AND ALL APPLICABLE LOCAL, STATE AND FEDERAL REGULATIONS.
 7. ALL WORK SHALL BE IN ACCORDANCE WITH THE NATIONAL ELECTRICAL CODE (NEC) AND ALL APPLICABLE LOCAL, STATE AND FEDERAL REGULATIONS.
 8. ALL WORK SHALL BE IN ACCORDANCE WITH THE NATIONAL ELECTRICAL CODE (NEC) AND ALL APPLICABLE LOCAL, STATE AND FEDERAL REGULATIONS.
 9. ALL WORK SHALL BE IN ACCORDANCE WITH THE NATIONAL ELECTRICAL CODE (NEC) AND ALL APPLICABLE LOCAL, STATE AND FEDERAL REGULATIONS.
 10. ALL WORK SHALL BE IN ACCORDANCE WITH THE NATIONAL ELECTRICAL CODE (NEC) AND ALL APPLICABLE LOCAL, STATE AND FEDERAL REGULATIONS.

CONTRACTOR NOTES:
 1. ALL WIRING SHALL BE INSTALLED IN ACCORDANCE WITH THE NATIONAL ELECTRICAL CODE (NEC) AND ALL APPLICABLE LOCAL, STATE AND FEDERAL REGULATIONS.
 2. CONDUIT SHALL BE INSTALLED TO PROTECT ALL WIRING FROM PHYSICAL DAMAGE AND TO PROVIDE A NEAT AND PROFESSIONAL APPEARANCE.
 3. ALL WIRING SHALL BE INSTALLED IN ACCORDANCE WITH THE NATIONAL ELECTRICAL CODE (NEC) AND ALL APPLICABLE LOCAL, STATE AND FEDERAL REGULATIONS.
 4. ALL WORK SHALL BE IN ACCORDANCE WITH THE NATIONAL ELECTRICAL CODE (NEC) AND ALL APPLICABLE LOCAL, STATE AND FEDERAL REGULATIONS.
 5. ALL WORK SHALL BE IN ACCORDANCE WITH THE NATIONAL ELECTRICAL CODE (NEC) AND ALL APPLICABLE LOCAL, STATE AND FEDERAL REGULATIONS.
 6. ALL WORK SHALL BE IN ACCORDANCE WITH THE NATIONAL ELECTRICAL CODE (NEC) AND ALL APPLICABLE LOCAL, STATE AND FEDERAL REGULATIONS.
 7. ALL WORK SHALL BE IN ACCORDANCE WITH THE NATIONAL ELECTRICAL CODE (NEC) AND ALL APPLICABLE LOCAL, STATE AND FEDERAL REGULATIONS.
 8. ALL WORK SHALL BE IN ACCORDANCE WITH THE NATIONAL ELECTRICAL CODE (NEC) AND ALL APPLICABLE LOCAL, STATE AND FEDERAL REGULATIONS.
 9. ALL WORK SHALL BE IN ACCORDANCE WITH THE NATIONAL ELECTRICAL CODE (NEC) AND ALL APPLICABLE LOCAL, STATE AND FEDERAL REGULATIONS.
 10. ALL WORK SHALL BE IN ACCORDANCE WITH THE NATIONAL ELECTRICAL CODE (NEC) AND ALL APPLICABLE LOCAL, STATE AND FEDERAL REGULATIONS.

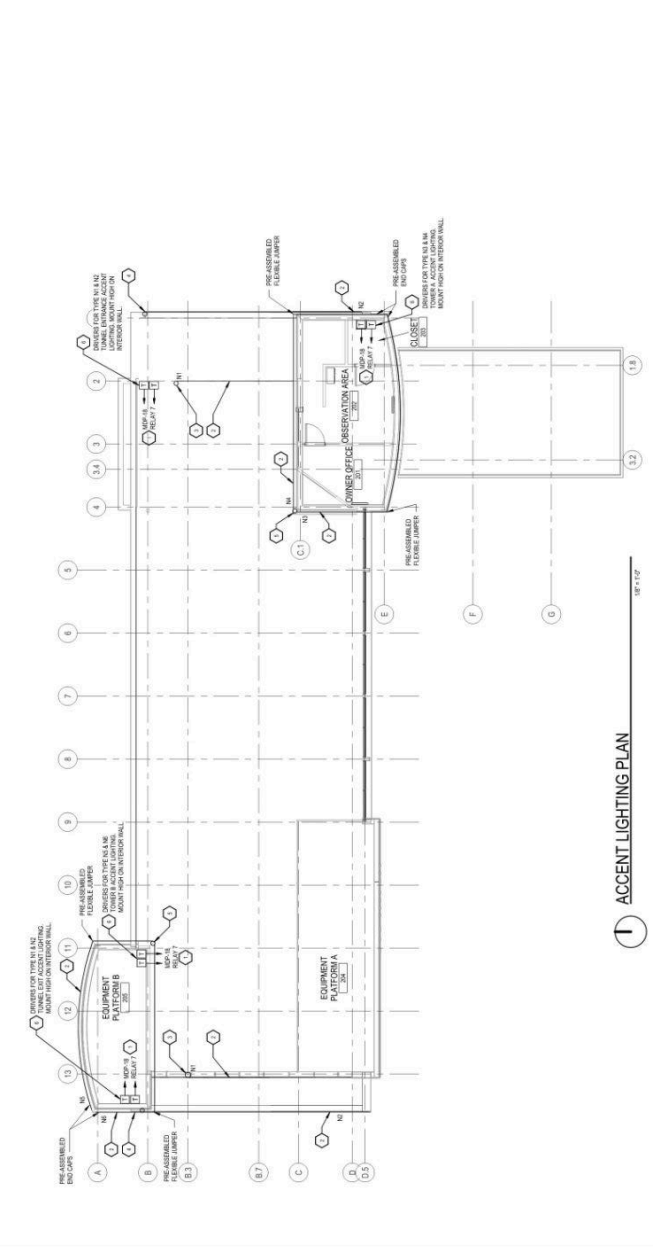

① ACCENT LIGHTING PLAN
8/8/23

EXTERIOR ACCENT LIGHTING FIXTURE SCHEDULE

TYPE	LAMP	WATT	MANUFACTURER	MODEL	DESCRIPTION	NOTES
N1	LED	40W	DOUGLAS	DOUGLAS	DOUGLAS	DOUGLAS
N2	LED	40W	DOUGLAS	DOUGLAS	DOUGLAS	DOUGLAS
N3	LED	40W	DOUGLAS	DOUGLAS	DOUGLAS	DOUGLAS
N4	LED	40W	DOUGLAS	DOUGLAS	DOUGLAS	DOUGLAS
N5	LED	40W	DOUGLAS	DOUGLAS	DOUGLAS	DOUGLAS
N6	LED	40W	DOUGLAS	DOUGLAS	DOUGLAS	DOUGLAS
N7	LED	40W	DOUGLAS	DOUGLAS	DOUGLAS	DOUGLAS
N8	LED	40W	DOUGLAS	DOUGLAS	DOUGLAS	DOUGLAS
N9	LED	40W	DOUGLAS	DOUGLAS	DOUGLAS	DOUGLAS
N10	LED	40W	DOUGLAS	DOUGLAS	DOUGLAS	DOUGLAS

24V Voltage Drop & Wire Length Distance Chart (3% Drop or 23.28V)*

WIRE GAUGE	18 W	20 W	30 W	40 W	50 W	60 W	70 W	80 W	90 W
12 AWG	42.4	83.4	1.7 A	2.1 A	2.5 A	2.9 A	3.3 A	3.7 A	4.1 A
14 AWG	13.4	26.8	4.5	5.7	6.9	8.1	9.3	10.5	11.7
16 AWG	21.5	43.0	7.2	9.1	10.9	12.7	14.5	16.3	18.1
18 AWG	34.5	69.0	11.5	14.4	17.2	20.1	22.9	25.8	28.6
20 AWG	53.9	107.8	18.1	22.7	27.2	31.7	36.2	40.7	45.2
22 AWG	78.4	156.8	28.3	35.4	42.5	49.6	56.7	63.8	70.9

*These tables provide general guidelines for determining wire gauge based on total load and distance from LED driver to beginning of luminaire.

7.2 Appendix B: Flex Model Accent Lighting Plan

A placeholder for Flex Model architectural drawings. This will be updated when final drawing sets are available.

7.3 Appendix C: Voltage Drop Chart

Voltage drop is the amount of voltage loss that occurs through all or part of a circuit due to resistance. Consider voltage drop when specifying your next project.

Use the chart below by first calculating the total wattage load, then selecting the length of wire needed.

24V voltage drop & wire length distance chart (3% drop or 23.28V)*

WIRE GAUGE	5W .2 A	10W .42 A	20W .83 A	30W 1.3 A	40W 1.7 A	50W 2.1 A	60W 2.5 A	70W 2.9 A	80W 3.3 A	90W 3.75 A	100W 4.2 A
22 AWG	107 ft.	52 ft.	27 ft.	17 ft.	13 ft.	10.5 ft.	9 ft.	7.5 ft.	6.8 ft.	6 ft.	5.3 ft.
20 AWG	170 ft.	85 ft.	43 ft.	27 ft.	21 ft.	17 ft.	14 ft.	12 ft.	11 ft.	9 ft.	8 ft.
18 AWG	270 ft.	134 ft.	68 ft.	45 ft.	33 ft.	27 ft.	22 ft.	19 ft.	17 ft.	15 ft.	14 ft.
16 AWG	430 ft.	215 ft.	109 ft.	72 ft.	54 ft.	43 ft.	36 ft.	31 ft.	27 ft.	24 ft.	22 ft.
14 AWG	680 ft.	345 ft.	174 ft.	115 ft.	86 ft.	69 ft.	57 ft.	49 ft.	43 ft.	39 ft.	36 ft.
12 AWG	1090 ft.	539 ft.	272 ft.	181 ft.	135 ft.	108 ft.	90 ft.	77 ft.	68 ft.	61 ft.	56 ft.
10 AWG	1730 ft.	784 ft.	397 ft.	263 ft.	197 ft.	158 ft.	131 ft.	112 ft.	98 ft.	97 ft.	82 ft.

12V voltage drop & wire length distance chart (3% drop or 11.64v)*

WIRE GAUGE	5W .42 A	10W .83 A	20W 1.7 A	30W 2.5 A	40W 3.3 A	50W 4.16 A	60W 5 A
22 AWG	27 ft.	14 ft.	7 ft.	4.5 ft.	3.5 ft.	2.8 ft.	2.2 ft.
20 AWG	43 ft.	18 ft.	9 ft.	6 ft.	5 ft.	4 ft.	3 ft.
18 AWG	68 ft.	34 ft.	17 ft.	11 ft.	8 ft.	6 ft.	5 ft.
16 AWG	110 ft.	54 ft.	27 ft.	18 ft.	13 ft.	10 ft.	9 ft.
14 AWG	170 ft.	86 ft.	43 ft.	29 ft.	21 ft.	17 ft.	14 ft.
12 AWG	275 ft.	134 ft.	68 ft.	45 ft.	34 ft.	27 ft.	22 ft.
10 AWG	430 ft.	199 ft.	99 ft.	66 ft.	49 ft.	39 ft.	33 ft.

3% voltage drop rule

This condition causes the load to work harder with less voltage pushing the current. The National Electrical Code recommends limiting the voltage drop from the breaker box to the farthest outlet for power, heating, or lighting to 3 percent of the circuit voltage.

7.4 Appendix D: Product Specification Sheets

The following pages contain manufacturer data sheets for all standard components included in the Tommy's Accent Lighting Package.

Please note that any variations between part numbers shown on the specification sheets and the specific items listed in this manual or provided to the site are due to factory assembly adjustments. These include customized lengths, pre-installed connectors, and specific IP ratings as required for each application.



NEON BLAZE™ Diffused LED Lighting

Specification Sheet

NEON BLAZE™ 24V Diffused LED Lighting

Diffused, neon-like LED lighting with top-bending and side-bending options. Available in static white and colors, and suitable for wet locations (IP65).

Date _____

Project Notes _____



FEATURES

- Fully diffused, dotless light
- Top-bending and side-bending options with multiple output levels
- IP65 for wet locations and UV stabilized for outdoor use
- Ideal for coves and other architectural details
- 5 Year limited warranty



ORDERING CODES

Order spools, and components for field assembly

OPTIONAL ORDERING CODES

Add Length, Assembly Preferences, Finish, Mounting, Driver, and Delivery

	Voltage	Bend Style	Model	CCT		Length	Channels	Finish	Mounting	Driver	Delivery	
DI	24V (24V Volt)	SE (Side Bending) TE (Top Bending)	NBL1 NBL2 NBL4	27 (2700K) 30 (3000K) 35 (3500K) 42 (4200K) 63 (6300K)	GL (Amber) BL (Blue) GR (Green) PK (Pink) RD (Red)	016 (16 feet) 32 (32 feet) 65 (65 feet)	MTCH (Neon Top Bend) SPN (Neon Top Spine) MTCH (Neon Side Bend) SPN (Neon Side Spine)	AL (Aluminum)	TUC (Top U-Clip) BUC (Bottom U-Clip)	ELV (Electronic) VLM (Constant Voltage) 010 (0-10V) LUT (Lutron)	MAG (MLV) O10 (On / Off) PoE (Power over Ethernet)	Field Assembly Factory + Field (Hybrid)

NEON BLAZE™ - SPECIFICATION TABLE

Models	24V-SE-NBL1	24V-SE-NBL2	24V-SE-NBL4	24V-TE-NBL1	24V-TE-NBL2	24V-TE-NBL4
Voltage	24VDC	24VDC	24VDC	24VDC	24VDC	24VDC
Wattage	1.22W/ft.	2.44W/ft.	4.4W/ft.	1.22W/ft.	2.44W/ft.	4.4W/ft.
2700K	62 Lm/ft.	134 Lm/ft.	208 Lm/ft.	86 Lm/ft.	173 Lm/ft.	248 Lm/ft.
3000K	65 Lm/ft.	146 Lm/ft.	198 Lm/ft.	102 Lm/ft.	219 Lm/ft.	317 Lm/ft.
3500K	60 Lm/ft.	120 Lm/ft.	195 Lm/ft.	89 Lm/ft.	155 Lm/ft.	228 Lm/ft.
4200K	-	120 Lm/ft.	-	-	-	-
Lumens 6300K	59 Lm/ft.	116 Lm/ft.	173 Lm/ft.	88 Lm/ft.	145 Lm/ft.	225 Lm/ft.
Amber	31 Lm/ft.	61 Lm/ft.	84 Lm/ft.	70 Lm/ft.	157 Lm/ft.	184 Lm/ft.
Blue	6 Lm/ft.	12 Lm/ft.	18 Lm/ft.	18 Lm/ft.	30 Lm/ft.	37 Lm/ft.
Green	30 Lm/ft.	-	78 Lm/ft.	88 Lm/ft.	148 Lm/ft.	151 Lm/ft.
Pink	17 Lm/ft.	37 Lm/ft.	53 Lm/ft.	39 Lm/ft.	93 Lm/ft.	110 Lm/ft.
Red	11 Lm/ft.	21 Lm/ft.	34 Lm/ft.	31 Lm/ft.	61 Lm/ft.	64 Lm/ft.
Cut Points	2 in.	2 in.	2 in.	2 in.	2 in.	2 in.
Max Run (ft.)	65 ft.	32 ft.	16 ft.	65 ft.	32 ft.	16 ft.
CRI	80+	80+	80+	80+	80+	80+
Dimensions	0.37 x 0.75 in. (W x H)	0.37 x 0.75 in. (W x H)	0.37 x 0.75 in. (W x H)	0.65 x 0.59 in. (W x H)	0.65 x 0.59 in. (W x H)	0.65 x 0.59 in. (W x H)
TM-21 (LM-80)	>50,000 hours	>50,000 hours	>50,000 hours	>50,000 hours	>50,000 hours	>50,000 hours
Environment	Outdoor / Wet Location (IP65)	Outdoor / Wet Location (IP65)	Outdoor / Wet Location (IP65)	Outdoor / Wet Location (IP65)	Outdoor / Wet Location (IP65)	Outdoor / Wet Location (IP65)
Certification	UL Listed 2108	UL Listed 2108	UL Listed 2108	UL Listed 2108	UL Listed 2108	UL Listed 2108
Warranty	5 Year	5 Year	5 Year	5 Year	5 Year	5 Year

NEON BLAZE™ 24V
Diffused LED Lighting

Diffused, neon-like LED lighting with top-bending and side-bending options. Available in static white and colors, and suitable for wet locations (IP65).

Date _____
Project Notes _____



MECHANICAL DIAGRAMS

24V-SE-NBL1
24V-SE-NBL2
24V-SE-NBL4

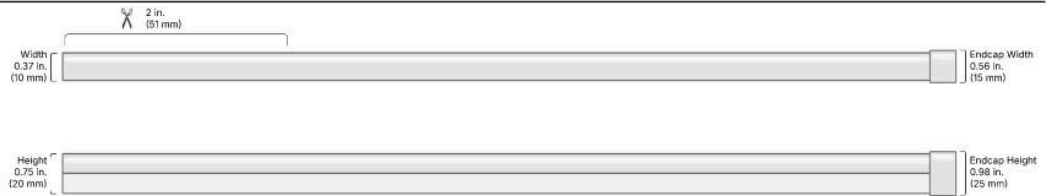

24V-TE-NBL1
24V-TE-NBL2
24V-TE-NBL4

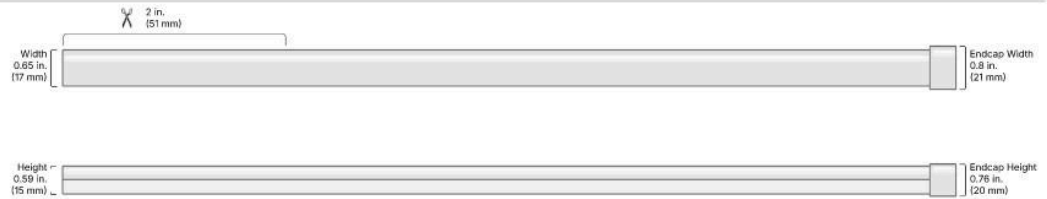

NEON BLAZE™ 24V
Diffused LED Lighting

Diffused, neon-like LED lighting with top-bending and side-bending options. Available in static white and colors, and suitable for wet locations (IP65).

Date _____

Project Notes _____



ACCESSORIES

DI-NB-96M-CNCT

NEON BLAZE Top and Side Emitting Male connector with 96" lead

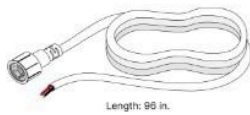

Length: 96 in.

DI-SE-NB-STWC-EC

NEON BLAZE Side Bending, Straight Wire Entry Connector and Frosted end cap pair

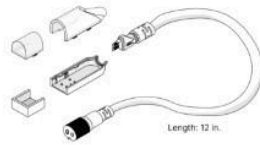

Length: 12 in.

DI-SE-NB-STBW-20

NEON BLAZE Side Bending, Straight Wire Splice Connector, 20 ft.

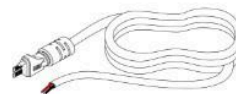

Length: 20 ft.

DI-SE-NB-ST-FR-EC

NEON BLAZE Side Bending, Straight Wire Entry Frosted end cap pair only (no lead wire)

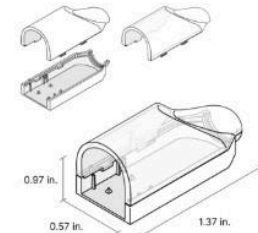

0.97 in.

0.57 in.

1.37 in.

DI-SE-NB-TTT-2

NEON BLAZE Side Bending, Strip to Strip Connector Frosted, Pack of 2

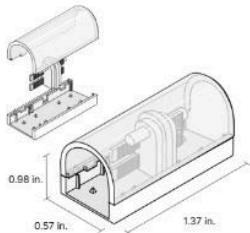

0.98 in.

0.57 in.

1.37 in.

DI-SE-NB-JPR

NEON BLAZE Side Bending Jumper with Frosted top cap and end cap

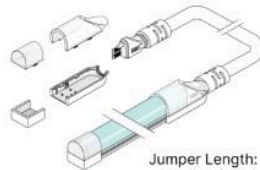

Jumper Length:
3JPR - (3 in.)
6JPR - (6 in.)
12JPR - (12 in.)
24JPR - (24 in.)

DI-SE-NB-SDWC-EC

NEON BLAZE Side Bending, Side Wire Entry Connector and Frosted end cap pair

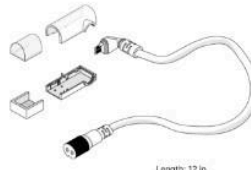

Length: 12 in.

DI-SE-NB-SDWC-EC-FDC

NEON BLAZE Side Bending, Side wire entry connector and frosted end cap pair, Female DC Plug

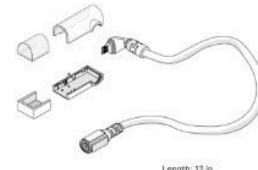

Length: 12 in.

DI-SE-NB-SD-FR-EC

NEON BLAZE Side Bending, Side Wire Entry Frosted end cap pair only (no lead wire)

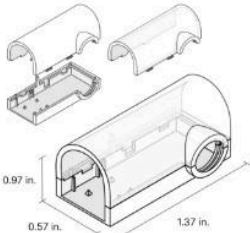

0.97 in.

0.57 in.

1.37 in.

DI-SE-NB-BWC-EC

NEON BLAZE Side Bending, Bottom Wire Entry Connector and Frosted end cap pair

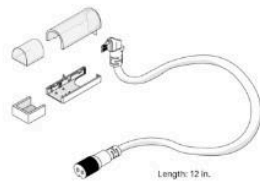

Length: 12 in.

DI-SE-NB-B-FR-EC

NEON BLAZE Side Bending, Bottom Wire Entry Frosted end cap pair only (no lead wire)

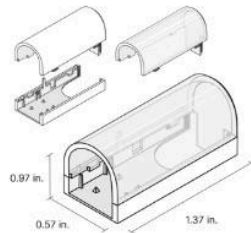

0.97 in.

0.57 in.

1.37 in.

DI-SE-NB-EC-5

NEON BLAZE, Side Emitting, End Cap Pair, 5 Pack

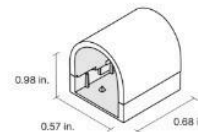

0.98 in.

0.57 in.

0.68 in.

NEON BLAZE™ 24V
Diffused LED Lighting

Diffused, neon-like LED lighting with top-bending and side-bending options. Available in static white and colors, and suitable for wet locations (IP65).

Date _____

Project Notes _____



SIDE BENDING ACCESSORIES

DI-SE-NB-BUC-16

NEON BLAZE Side Emitting, Bottom U-clip, Bag of 16

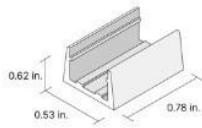

DI-SE-NB-TUC-16

NEON BLAZE Side Emitting, Top U-clip, Bag of 16



DI-SE-NB-MTCH

NEON BLAZE Side Emitting, 35" inch channel

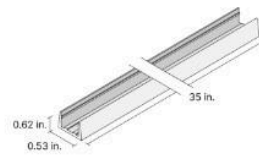

DI-SE-NB-FLCH-WH

NEON BLAZE Flexible Spine Channel, Side Bending, 1m, White

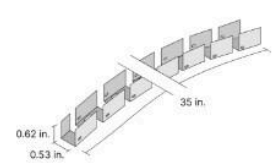

TOP BENDING ACCESSORIES

DI-NB-96M-CNCT

NEON BLAZE Top and Side Emitting Male connector with 96" lead

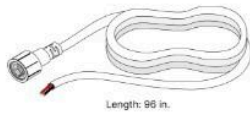

DI-TE-NB-STWC-EC



DI-TE-NB-STBW-20

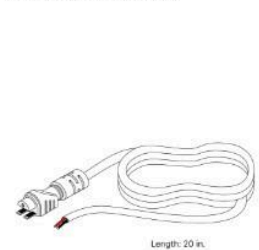

DI-TE-NB-ST-FR-EC

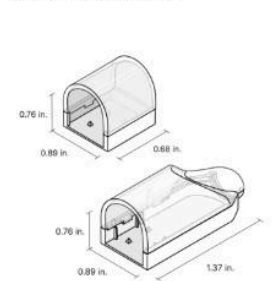

DI-TE-NB-TTT-2

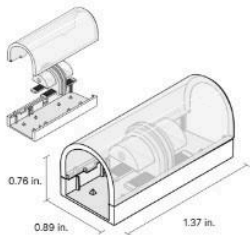

DI-TE-NB-JPR

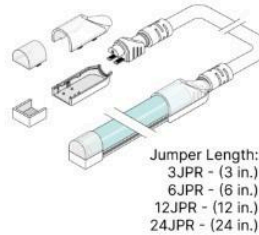

DI-TE-NB-SDWC-EC

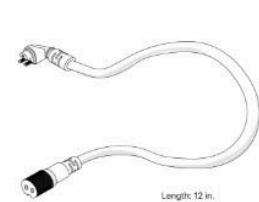

DI-TE-NB-SDWC-EC-FDC

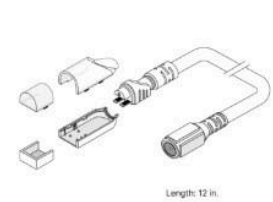

NEON BLAZE™ 24V
Diffused LED Lighting

Diffused, neon-like LED lighting with top-bending and side-bending options. Available in static white and colors, and suitable for wet locations (IP65).

Date _____

Project Notes _____



TOP BENDING ACCESSORIES

DI-TE-NB-BWC-EC

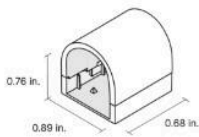

DI-TE-NB-B-FR-EC

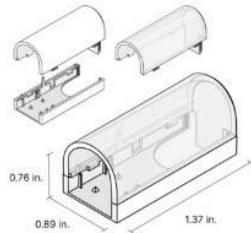

DI-TE-NB-EC-5

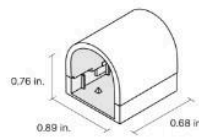

DI-TE-NB-BUC-16

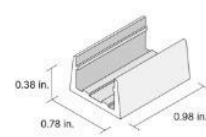

DI-TE-NB-TUC-16



DI-TE-NB-MTCH

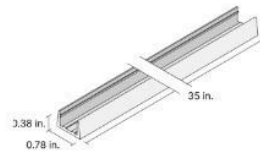

DI-TE-NB-FLCH-WH



DELIVERY OPTIONS

- **Field Assembly**
Fastest order fulfillment. Field connectors and accessories not included.
- **Factory + Field (Hybrid)**
Onsite modifications with factory connection. Additional accessories not included.

- Lumen value measured in accordance to IES LM-80-08. LED chips have a luminous flux range with a tolerance of +/- 5%.
- Each maximum run requires a dedicated power feed from the driver. Do not extend beyond the recommended maximum run length. Max run may exceed Class 2 limit. Actual wattage may differ from calculated wattage due to voltage drop across run.
- Do not install product in an environment outside the listed ambient temperature. Exceeding the maximum ambient temperature may damage LED chips, reduce the total lamp life, lumen output, and/or adversely impact color consistency.
- Actual efficacy value is dependent to specified LED driver (power supply). An estimated efficacy value can be calculated as follows: Lumen value divided by average power consumption per foot.
- Operating temperature is measured according to the minimum and maximum ambient temperature environment.



NEON BLAZE™ Diffused LED Lighting

Specification Sheet

NEON BLAZE™ 24V Diffused LED Lighting

Diffused, neon-like LED lighting with top-bending and side-bending options. Available in static white and colors, and suitable for wet locations (IP65).

Date _____

Project Notes _____



CERTIFICATIONS

Safety

- UL Listed 2108 Low Voltage Lighting System / Low Voltage Luminaire. UL 1598 / CSA 250.0-08, UL 8750. UL 879 / CAN/CSA-C22.2 no. 207-M89. Certified for United States and Canada. File # E469769.
- UL Listed Field Cuttable.
- CE & EMC Compliant.
- Approved for storage areas of clothes closets per NEC 410.16.A.3 and 410.16.C.5.

Environment

- Ambient Temperature: -4 ~ 122°F (-20 ~ 50°C)
- Operating Temperature: -4 ~ 176°F (-20 ~ 80°C)
- RoHS Compliant.

Performance

- LED chip data measured in accordance to IES LM-80-08.
- Photometric & Colorimetry data measured in accordance to IES LM-79-08, in Elemental LED's Innovation Lab.

Safety / Warnings / Disclosures

1. Install in accordance with national and local electrical code regulations.
2. This product is intended to be installed and serviced by a qualified, licensed electrician.
3. Only use copper wiring. Use wires rated for at least 176°F (80°C) and certified for use with external connection of electrical equipment.
4. Each maximum run requires a dedicated power feed from the driver. Do not extend beyond the recommended maximum run length.
5. Tape light, attached wire leads, and additional extension cables, connectors, etc., are not rated for in-wall installation unless otherwise noted. Tape light and attached wire leads are field-cuttable.
6. Ensure applicable wire is installed between driver, fixture, and any controls in-between. When choosing wire, factor in voltage drop, amperage rating, and type (in-wall rated, wet location rated, etc.). Inadequate wire installation could overheat wires, and cause fire.
7. Do not install in environment where LED chips are exposed to direct sunlight as damage to the phosphor will occur.
8. Do not install in environment where excessive heat may exist (ex. close proximity to fireplace, etc.) See Ambient Temperature ratings.
9. Do not modify product beyond instructions or warranty will be void.
10. Tape light must be handled with care. Excessive handling, bending, and pressure may damage the product, voiding the warranty.
11. Actual color may vary from what is pictured on this sheet and other print materials due to the limitations of photographic processes.
12. We reserve the right to modify and improve the design of our fixtures without prior notice. We cannot guarantee to match existing installed fixtures for subsequent orders or replacements in regards to product appearance, CCT, or lumen output.

WARRANTY

Limited Warranty

- 5 Year limited warranty

This warranty does not include the additional accessories referenced in this specification sheet. Complete warranty details for fixtures and additional accessories are available at www.diodeled.com/limited-warranty/ within the Policies section. For warranty related questions please contact product support.

Consumer's Acknowledgment

Elemental LED, Inc. stands behind its products when they are used properly and according to our specifications. By purchasing our products, the purchaser agrees and acknowledges that lighting design, configuration and installation is a complex process, wherein seemingly minor factors or changes in layout and in-field adjustments can have a significant impact on an entire system. Choosing the correct components is essential. Elemental LED is able to work with the original purchaser to make an appropriate product selection to the extent of the limited information that the customer can provide, but it is virtually impossible for Elemental LED to design a system that foresees every unknown factor. For this reason, this Warranty does not cover problems caused by improper design, configuration or installation issues. Any statement from a Elemental LED employee or agent regarding a customer's bill of goods and/or purchase order is NOT an acknowledgment that the products purchased are designed and configured correctly. The purchase agrees and acknowledges that it is the customer's responsibility to adhere strictly to all information contained in the Product Specification Sheets.

There is often more than one way to design, configure and layout an LED lighting application properly to achieve the same lighting effect. Elemental LED strongly recommends that licensed professionals be used in the design and installation of lighting systems that include Elemental LED products. The specifications include important information that a designer and installer should carefully review and strictly follow. Qualified designers and certified and/or licensed installers, with access to the final installation environment, customer goals, and Elemental LED product specifications can make the requisite decisions appropriate for a successful finished lighting application.



OMNIDRIVE® X Dimmable Driver

Specification Sheet

OMNIDRIVE® X 12V and 24V Dimmable Driver

Versatile driver for most high-performance dimming on ELV, TRIAC, and 0-10V systems.
Dims to dark depending on installation.

Date _____

Project Notes _____



24 VDC

12 VDC

TITLE 24

FEATURES

- ELV, Triac, and 0-10V dimming in one unit
- 0.1% Performance Dimming, Dim to Dark
- 110-277VAC universal input
- No minimum load
- UL listed and JAS compliant
- Optional Indoor/Outdoor NEMA3R Junction Box
- 5 Year limited warranty



24V ORDERING CODES

Driver Only

Model	24V Voltage/Wattage	
ODX	24V120W-J (24 Volt / 120 Watt w/ Junction Box)	24V60W (24 Volt / 60 Watt)
	24V200W-J (24 Volt / 200 Watt w/ Junction Box)	24V60W-J (24 Volt / 60 Watt w/ Junction Box)
	24V30W (24 Volt / 30 Watt)	24V96W (24 Volt / 96 Watt)
	24V30W-J (24 Volt / 30 Watt w/ Junction Box)	24V96W-J (24 Volt / 96 Watt w/ Junction Box)

RECOMMENDED DRIVERS & CONTROLS

- LUTRON: Awn (Athena Wireless Node)
- LUTRON: Ariadni - AYLV-600P
- LUTRON: Caseta - PD-6WCL
- LUTRON: Caseta - PD-6NE
- LUTRON: Caseta - PD-10XND
- LUTRON: Caseta - DVERF-6
- LUTRON: Diva - DVCLV-300P
- LUTRON: Diva - DVCLV-153-P
- LUTRON: Diva - DV600P
- LUTRON: Diva - 0-10V DVTV
- LUTRON: Homeworks - HWD END WH
- LUTRON: Homeworks QS - HQRD END
- LUTRON: Maestro - MAELV-600
- LUTRON: Maestro - MBF2-6ND-120
- LUTRON: Maestro - MA-PRO
- LUTRON: Nova T+ CL - NTCL 250
- LUTRON: Nova T - NTLV-603P
- LUTRON: Nova T - NTFTV
- LUTRON: Nova - NFTV
- LUTRON: Radio RA2 - RR0-10ND
- LUTRON: Radio RA2 - RR0 ECL WH
- LUTRON: Venti - VT-100DMN
- LEVITON: Decora - DSE06-102
- LEVITON: Illumtech - IP10-LF2
- LEVITON: Decora Smart - DSWBD-1B2
- LEGRAND: Paddle - ADPO453LW2
- MISC.: Forbes & Lomax MLV - FLRLV603P
- MISC.: Forbes & Lomax INCHAL - FLR603P

OMNIDRIVE® X - SPECIFICATION TABLE

Models	ODX-24V30W	ODX-24V60W	ODX-24V96W	ODX-24V120W	ODX-24V200W
Input Voltage / Frequency	120-277VAC	120-277VAC	120-277VAC	120-277VAC	120-277VAC
Maximum Load	30W	60W	96W	120W	200W
Output Voltage	24VDC	24VDC	24VDC	24VDC	24VDC
Efficiency	>83%	>83%	>83%	>83%	>83%
Class 2	Yes	Yes	Yes	No	No
Ambient Temperature	-40 ~ +140°F (-40 ~ +60°C)	-40 ~ +140°F (-40 ~ +60°C)	-40 ~ +140°F (-40 ~ +60°C)	-40 ~ +140°F (-40 ~ +60°C)	-40 ~ +140°F (-40 ~ +60°C)
Operating Temperature	-22 ~ 158°F (-30 ~ +70°C)	-22 ~ 158°F (-30 ~ +70°C)	-22 ~ 158°F (-30 ~ +70°C)	-22 ~ 158°F (-30 ~ +70°C)	-22 ~ 158°F (-30 ~ +70°C)
Minimum Load	No Minimum Load	No Minimum Load	No Minimum Load	No Minimum Load	No Minimum Load
Dimmable	Yes	Yes	Yes	Yes	Yes
Input Connection Type	Terminal	Terminal	Wire	Wire	Wire
Output Connection Type	Terminal	Terminal	Wire	Wire	Wire
Internal Protection	Shut down, recovers automatically after fault condition is removed	Shut down, recovers automatically after fault condition is removed	Shut down, recovers automatically after fault condition is removed	Shut down, recovers automatically after fault condition is removed	Shut down, recovers automatically after fault condition is removed
Environment	W/Junction Box: Outdoor / Wet Location (NEMA3R) W/o Junction Box: Indoor / Damp Location (IP20) (IP20)	W/Junction Box: Outdoor / Wet Location (NEMA3R) W/o Junction Box: Indoor / Damp Location (IP20) (IP20)	W/Junction Box: Outdoor / Wet Location (NEMA3R) W/o Junction Box: Indoor / Damp Location (IP65) (IP65)	Outdoor / Wet Location (NEMA3R)	Outdoor / Wet Location (NEMA3R)
Working Humidity	20 - 95%RH,non-condensing	20 - 95%RH,non-condensing	20 - 95%RH,non-condensing	20 - 95%RH,non-condensing	20 - 95%RH,non-condensing
Dimensions	6.1 × 2.1 × 0.8 in. (L x W x H)	7 × 2.4 × 1 in. (L x W x H)	9 × 2.7 × 1.7 in. (L x W x H)	8.66 × 3.7 × 1.57 in. (L x W x H)	10.24 × 4.13 × 1.77 in. (L x W x H)
Certification	cULus (US & Canada) Listed, UL # E499308, ANSI/UL 1310 Power Unit, CAN/CSA-C22.2 No.250.13, Class P, FCC Part 15 Compliant	cULus (US & Canada) Listed, UL # E499308, ANSI/UL 1310 Power Unit, CAN/CSA-C22.2 No.250.13, Class P, FCC Part 15 Compliant	cULus (US & Canada) Listed, UL # E499308, ANSI/UL 1310 Power Unit, CAN/CSA-C22.2 No.250.13, Class P, FCC Part 15 Compliant	cULus (US & Canada) Listed, UL # E499308, ANSI/UL 1310 Power Unit, CAN/CSA-C22.2 No.250.13, Class P, FCC Part 15 Compliant	cULus (US & Canada) Listed, UL # E499308, ANSI/UL 1310 Power Unit, CAN/CSA-C22.2 No.250.13, Class P, FCC Part 15 Compliant
Warranty	5 Year	5 Year	5 Year	5 Year	5 Year
Junction Box	Optional	Optional	Optional	Required	Required

OMNIDRIVE® X 12V and 24V Dimmable Driver

Versatile driver for most high-performance dimming on ELV, TRIAC, and 0-10V systems.
Dims to dark depending on installation.

Date _____

Project Notes _____



24 VDC

12 VDC

TITLE 24

MECHANICAL DIAGRAMS

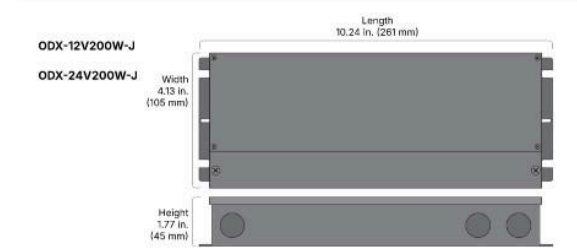
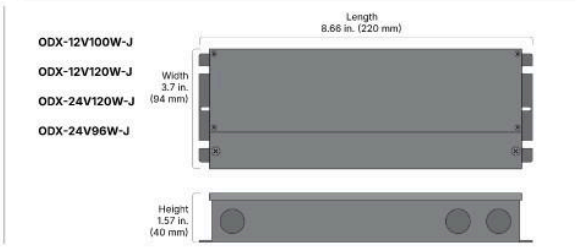
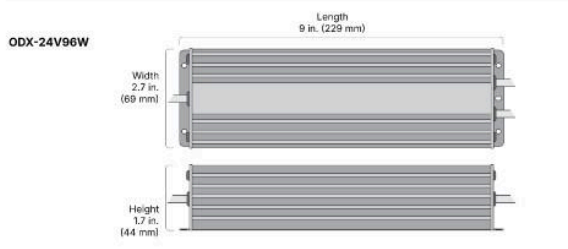
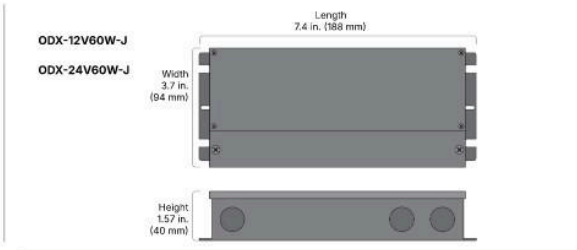
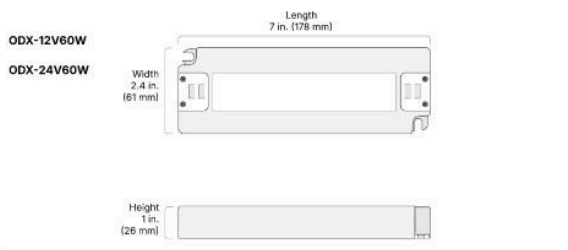
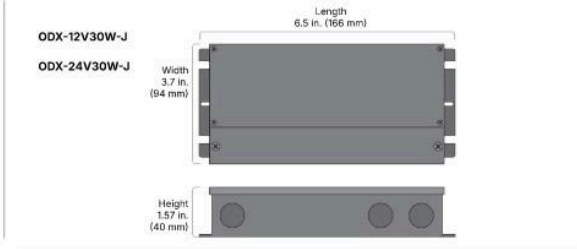
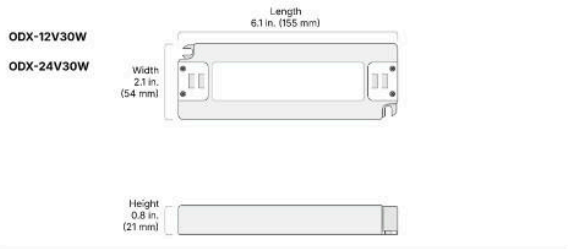

OMNIDRIVE® X 12V and 24V Dimmable Driver

Versatile driver for most high-performance dimming on ELV, TRIAC, and 0-10V systems. Dims to dark depending on installation.

Date _____
Project Notes _____



24 VDC

12 VDC

TITLE 24

SYSTEM DIAGRAMS

ELECTRONIC

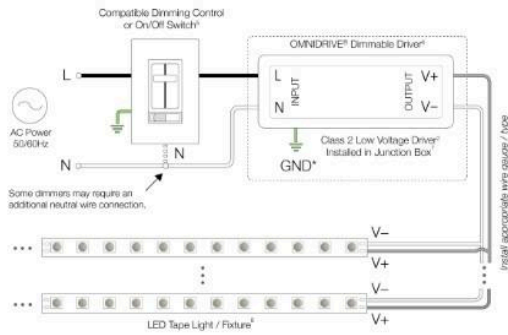

0-10V (No Relay)

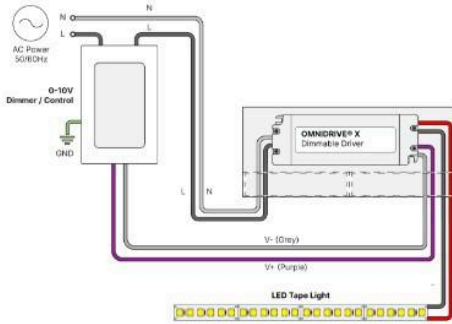

0-10V (With Relay)

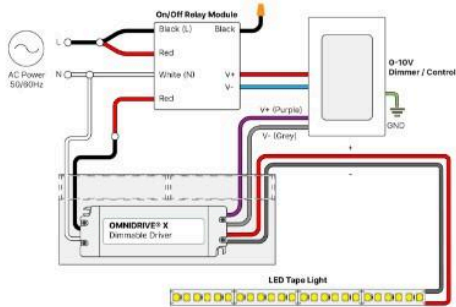

DERATION CURVE

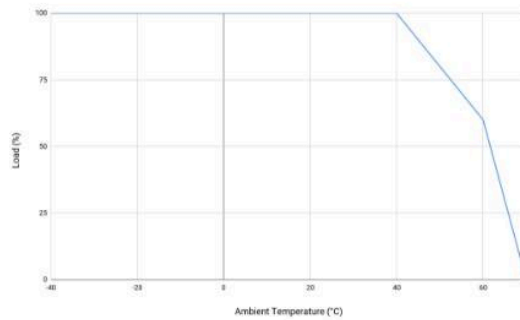



OMNIDRIVE® X Dimmable Driver

Specification Sheet

OMNIDRIVE® X 12V and 24V Dimmable Driver

Versatile driver for most high-performance dimming on ELV, TRIAC, and 0-10V systems.
Dims to dark depending on installation.

Date _____

Project Notes _____



24 VDC

12 VDC

TITLE 24

CERTIFICATIONS

Safety

- cULus (US & Canada) Listed, UL # E499308, ANSI/UL 8750, CAN/CSA-C22.2 No. 250.13, Class P
- Title 24 JAB/JAT0 Compliant

Safety / Warnings / Disclosures

1. Install in accordance with national and local electrical code regulations.
2. This product is intended to be installed and serviced by a qualified, licensed electrician.
3. Only use copper wiring. Use wires rated for at least 176°F (80°C) and certified for use with external connection of electrical equipment.
4. Each maximum run requires a dedicated power feed from the driver. Do not extend beyond the recommended maximum run length.
5. Ensure applicable wire is installed between driver, fixture, and any controls in-between. When choosing wire, factor in voltage drop, ampere rating, and type (in-wall rated, wet location rated, etc.). Inadequate wire installation could overheat wires, and cause fire.
6. Do not install in environment where excessive heat may exist (ex. close proximity to fireplace, etc.) See Ambient Temperature ratings.
7. Do not install indoor LED tape light products in outdoor / wet location environments. Only wet location tape light models are rated for outdoor / wet locations.
8. Do not modify product beyond instructions or warranty will be void.
9. Actual color may vary from what is pictured on this sheet and other print materials due to the limitations of photographic processes.
10. We reserve the right to modify and improve the design of our fixtures without prior notice. We cannot guarantee to match existing installed fixtures for subsequent orders or replacements in regards to product appearance, CCT, or lumen output.

WARRANTY

Limited Warranty

- 5 Year limited warranty

This warranty does not include the additional accessories referenced in this specification sheet. Complete warranty details for fixtures and additional accessories are available at www.diodeled.com/limited-warranty/ within the Policies section. For warranty related questions please contact product support.

Consumer's Acknowledgment

Elemental LED, Inc. stands behind its products when they are used properly and according to our specifications. By purchasing our products, the purchaser agrees and acknowledges that lighting design, configuration and installation is a complex process, wherein seemingly minor factors or changes in layout and in-field adjustments can have a significant impact on an entire system. Choosing the correct components is essential. Elemental LED is able to work with the original purchaser to make an appropriate product selection to the extent of the limited information that the customer can provide, but it is virtually impossible for Elemental LED to design a system that foresees every unknown factor. For this reason, this Warranty does not cover problems caused by improper design, configuration or installation issues. Any statement from an Elemental LED employee or agent regarding a customer's bill of goods and/or purchase order is NOT an acknowledgment that the products purchased are designed and configured correctly. The purchase agrees and acknowledges that it is the customer's responsibility to adhere strictly to all information contained in the Product Specification Sheets.

There is often more than one way to design, configure and layout an LED lighting application properly to achieve the same lighting effect. Elemental LED strongly recommends that licensed professionals be used in the design and installation of lighting systems that include Elemental LED products. The specifications include important information that a designer and installer should carefully review and strictly follow. Qualified designers and certified and/or licensed installers, with access to the final installation environment, customer goals, and Elemental LED product specifications can make the requisite decisions appropriate for a successful finished lighting application.

7.5 Appendix E: Product Installation Manuals

The following pages contain manufacturer installation instructions for all standard components included in the Tommy's Accent Lighting Package.

Please note that many of the reference components are factory-installed in the included kits and are to be reviewed for reference only. These include pre-installed entry wires, jumpers, connectors, spacers, and caps.



NEON BLAZE™ 24V LED Strip Light

INSTALLATION GUIDE

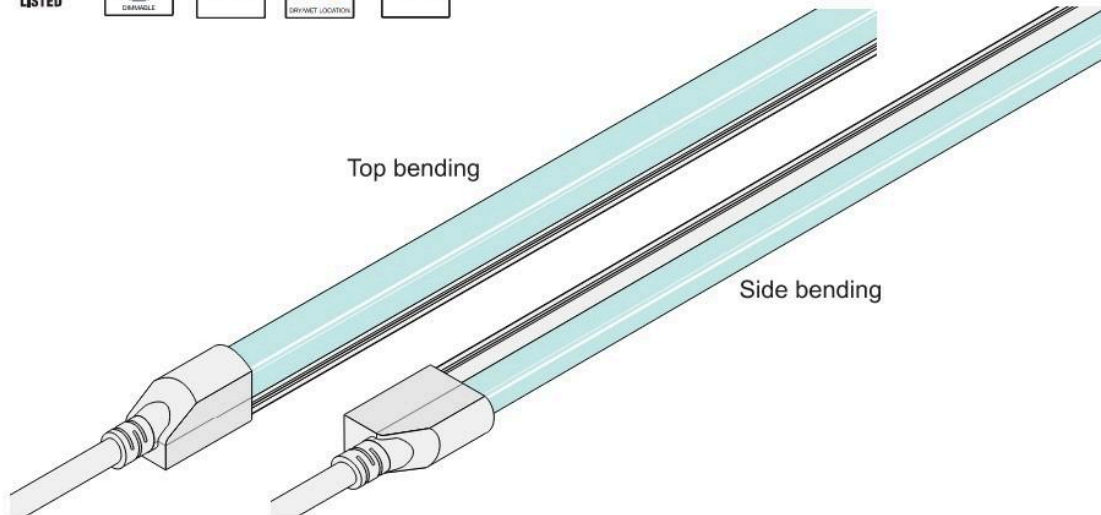

SAFETY & WARNINGS

READ AND FOLLOW ALL SAFETY INSTRUCTIONS

1. Install in accordance with national and local electrical code regulations.
2. This product is intended to be installed and serviced by a qualified, licensed electrician.
3. Do not modify or disassemble this product beyond instructions or the warranty will be void.
4. Do not use if there is any damage to the fixture or wiring. Inspect periodically.
5. Do not submerge Strip Light in liquids or use the product in the vicinity of standing water or other liquids.
6. Do not install near areas with exposure to chlorinated water. (Salt water environments are approved)
7. Do not attempt to fix this product in the field.
8. Failure to follow safety warnings, and installation instructions will void the warranty for this product.



QUICK SPECS / MODELS

Input	24VDC Constant Voltage
Power	1.2w/ft. / 2.7w/ft. / 4.4w/ft.
Ambient Temp †	-4° - 122°F (-20° - 50°C)
Environment	Indoor/Outdoor/IP65

† Do not install product in environment outside listed temperature.

***NOT FOR USE IN SUBMERSIBLE APPLICATIONS, OR WITHIN 5 FEET OF A SWIMMING POOL.**

NEON BLAZE™ 24V LED Strip Light

INSTALLATION GUIDE

REQUIRED TOOLS

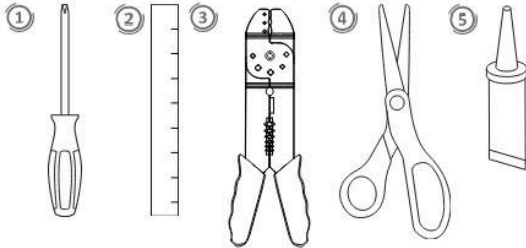

1. Phillips-head Screwdriver
2. Ruler (Recommended)
3. Wire Stripper (Recommended)
4. Cutting tool if cutting tape light to a specific length.
5. Sealant if cutting tape light to a specific length and installing in a wet location. Recommended sealant is the DI-WPSL, or equivalent.

HANDLE PRODUCT WITH CARE!



DO NOT POWER TAPE LIGHT WHILE ATTACHED TO SPOOL OR TIGHTLY COILED.

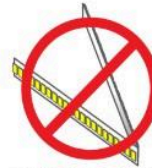

DO NOT FOLD, CREASE, OR TWIST LED TAPE LIGHT.

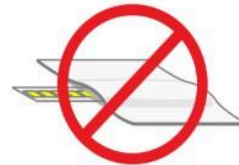

DO NOT COVER TAPE LIGHT WITH ANY MATERIALS.

TOP BENDING NEON BLAZE™ LED Strip Light

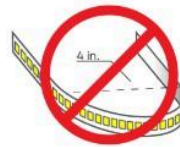

DO NOT BEND LED TAPE LIGHT TO A DIAMETER LESS THAN **4 INCHES**.



DO NOT BEND LED TAPE LIGHT ON A HORIZONTAL PLANE.

SIDE BENDING NEON BLAZE™ LED Strip Light

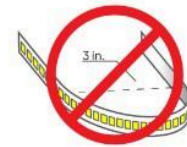

DO NOT BEND LED TAPE LIGHT TO A DIAMETER LESS THAN **3 INCHES**.

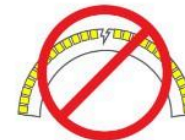

DO NOT BEND LED TAPE LIGHT ON A VERTICAL PLANE.

NEON BLAZE™ 24V LED Strip Light

INSTALLATION GUIDE

INSTALLATION

Note: Failure to follow installation instructions may void warranty.

1 TURN POWER OFF AT CIRCUIT BREAKER



SHOCK HAZARD! May result in serious injury or death.
Turn power OFF at circuit breaker prior to installation.

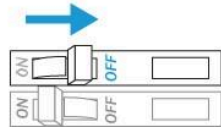

2 PREPARE NEON BLAZE™ LED STRIP FOR INSTALLATION

2.1 Before cutting or attaching connectors, ensure that the arrows on the underside of the Strip Light point away from initial connection.

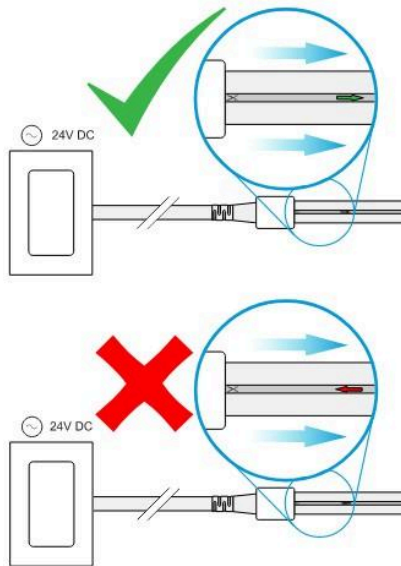

2.2 Skip to 3.3 if not cutting to specific length.

If cutting to length, ensure to cut the Strip Light at the designated cut points only. Cutting anywhere else will cause damage to the Strip Light.

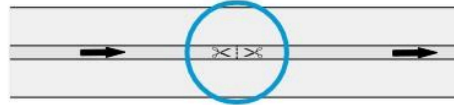

3 CREATE CONNECTION

TOP BENDING CONNECTOR

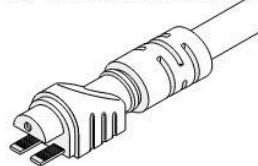

SIDE BENDING CONNECTOR

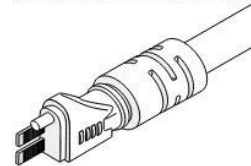

3.1 INSERT SPACER

Insert spacer directly **OVER** LED Strip Light allowing each arm of spacer to slide next to first LED. **Spacer must be used to maintain warranty.**

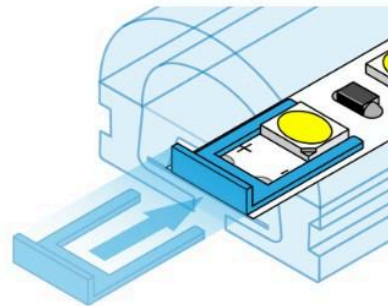

NEON BLAZE™ 24V LED Strip Light

INSTALLATION GUIDE

INSTALLATION (CONT.)

3.2 OPEN SPACE FOR CONNECTOR

Locate Plastic Backing underneath LED Strip Light. Using fingernail or small object, separate Backing from LED Strip Light.

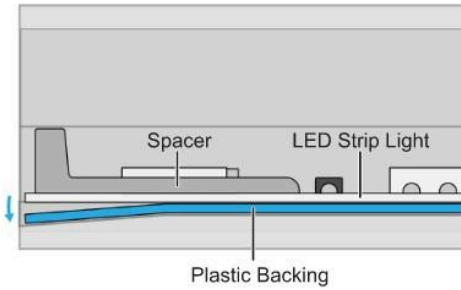

3.3 INSERT CONNECTOR

Slide blades of connector directly **UNDER** LED Strip Light, and **ABOVE** Plastic Backing, then press firmly.

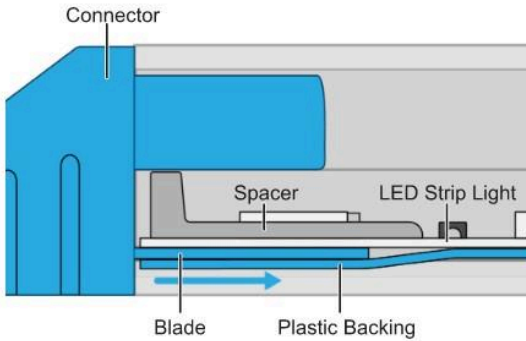

3.4 COVER CONNECTOR

Connect top and bottom halves of connector cover together completely surrounding connection point.

STRAIGHT WIRE ENTRY

**Top bending NEON BLAZE™ LED Strip Light shown.*

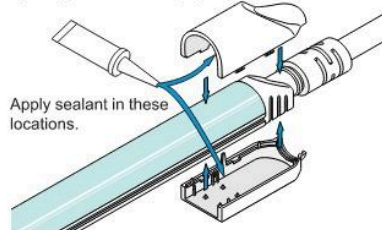

SIDE WIRE ENTRY

**Top bending NEON BLAZE™ LED Strip Light shown.*

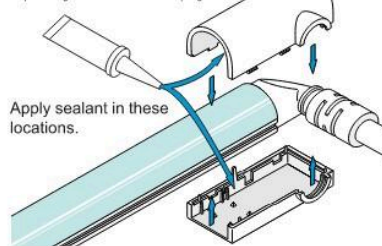

BOTTOM WIRE ENTRY

**Top bending NEON BLAZE™ LED Strip Light shown.*

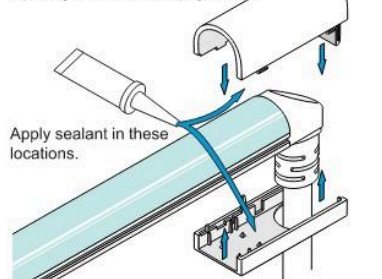

Press until cover snaps in place.

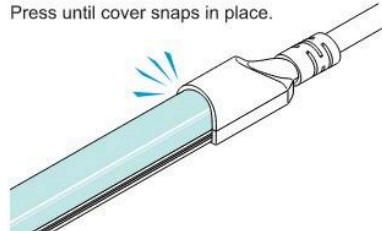

NEON BLAZE™ 24V LED Strip Light

INSTALLATION GUIDE

INSTALLATION (CONT.)

4 MOUNT NEON BLAZE™ LED STRIP LIGHT

Option A: Bottom U-Clips

- a Screw bottom u-clips to surface.
Note: It is recommended to use two bottom u-clips for every foot of NEON BLAZE™ LED Strip Light.

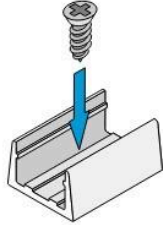

Insert NEON BLAZE™ LED Strip Light into bottom u-clip.

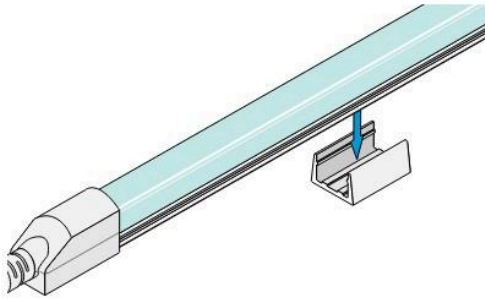

Option B: Top U-Clips

- b Place NEON BLAZE LED Strip Light on surface, then place clear top u-clip over Strip Light.

Note: It is recommended to use two clear top u-clips for every foot of NEON BLAZE™ LED Strip Light.

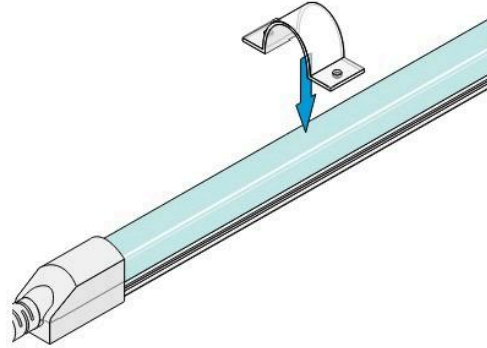

Screw top u-clip to surface.

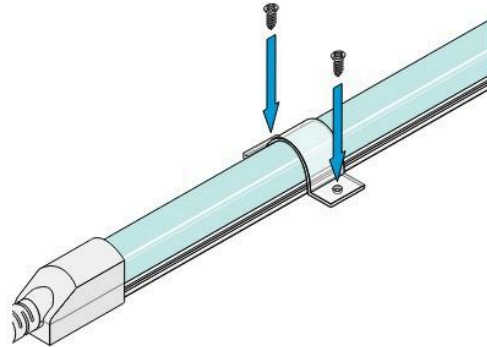

NEON BLAZE™ 24V LED Strip Light

INSTALLATION GUIDE

INSTALLATION (CONT.)

NEON BLAZE™ LED Strip Light may be bent to resemble neon lighting. Examples below:

Top bending NEON BLAZE™ LED Strip Light may be bent "up and down" on the vertical axis of the Strip Light.

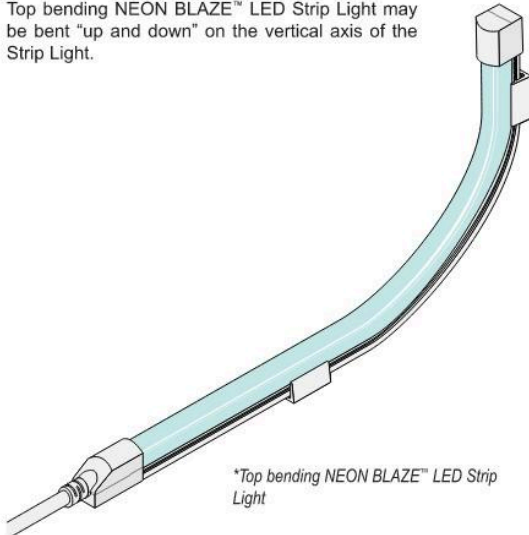

Side bending NEON BLAZE™ LED Strip Light may be bent "Left and Right" on the horizontal axis of the Strip Light.

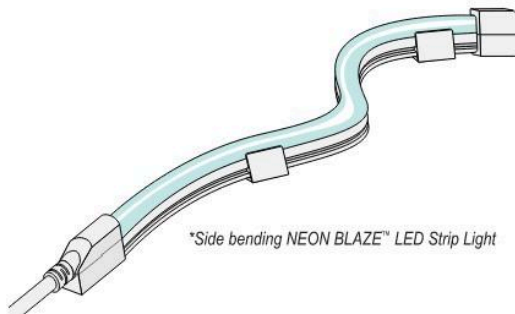

5 CONNECT TO 96" EXTENSION CABLE

Top bending and side bending connector will have wet location rated plug connector (female) on opposite end.

96" NEON BLAZE™ Extension cable will have wet location rated plug connector (male) on opposite end of splice connection.

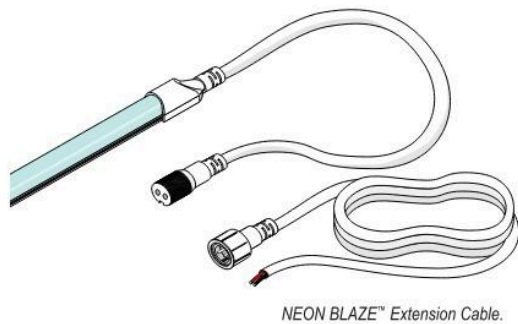

Screw connector cap onto extension cable securely.

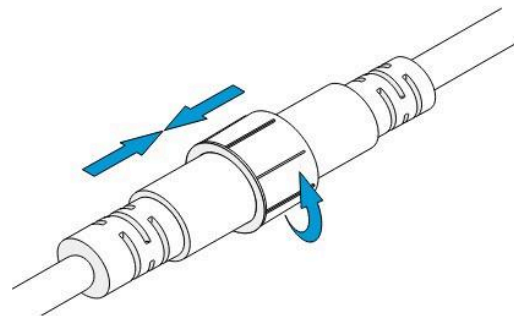

NEON BLAZE™ 24V LED Strip Light

INSTALLATION GUIDE

6 ATTACH DRIVER AND LIGHTING CONTROL.

Verify a compatible driver is installed. Utilize applicable wiring when installing outdoors. (Use of wet location-rated junction box recommended)

7 TURN POWER ON AT CIRCUIT BREAKER

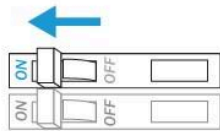

TOOLS & RESOURCES

NEON BLAZE™ SPECIFICATION SHEET
For full specifications.

VOLTAGE DROP CHART

For best performance and lumen output, ensure proper wire gauge is installed to compensate for voltage drop of low voltage circuits.

24V Voltage Drop & Wire Length Distance Chart

Wire Gauge	10 W .42 A	20 W .83 A	30 W 1.3 A	40 W 1.7 A	50 W 2.1 A	60 W 2.5 A	70 W 2.9 A	80 W 3.3 A	100 W 4.2 A
18 AWG	134 ft.	68 ft.	45 ft.	33 ft.	27 ft.	22 ft.	19 ft.	17 ft.	14 ft.
16 AWG	215 ft.	109 ft.	72 ft.	54 ft.	43 ft.	36 ft.	31 ft.	27 ft.	22 ft.
14 AWG	345 ft.	174 ft.	115 ft.	86 ft.	69 ft.	57 ft.	49 ft.	43 ft.	36 ft.
12 AWG	539 ft.	272 ft.	181 ft.	135 ft.	108 ft.	90 ft.	77 ft.	68 ft.	56 ft.
10 AWG	784 ft.	397 ft.	263 ft.	197 ft.	158 ft.	131 ft.	112 ft.	98 ft.	82 ft.

Example: 24V Voltage Drop & Wire Length Distance Chart

- Determine load size. Let's assume load is 55 W. Round up to nearest load.
- Determine distance from driver to load. Let's assume the distance is 90 ft.
- It is recommended to install 12 AWG to eliminate excess voltage drop.

TROUBLESHOOTING

Shift in brightness and/or kelvin	<ul style="list-style-type: none"> Ensure an appropriate gauge of wire is installed between strip light and LED driver. See VOLTAGE DROP CHARTS.
Some LEDs are not functional	<ul style="list-style-type: none"> Ensure strip light has not been bent excessively, which could damage circuitry. Ensure strip light has not been submerged in any liquid for any amount of time.
Lights are flickering	<ul style="list-style-type: none"> Ensure a compatible driver and/or dimming control is installed. Check for loose connections.
Lights are turning on/off repeatedly	<ul style="list-style-type: none"> Ensure driver is not overloaded. An overloaded driver will trip the internal auto-reset (of driver) repeatedly, turning the system on/off.

NEON BLAZE™ 24V LED Strip Light

INSTALLATION GUIDE

SYSTEM DIAGRAMS

The following diagrams are provided as example system designs. For information regarding larger systems or systems not pictured below, please see our web page or contact technical support. Always review each component installation guide for detailed and up-to-date wiring instructions. Install in accordance with national and local electrical codes.

Traditional ON/OFF Switch System

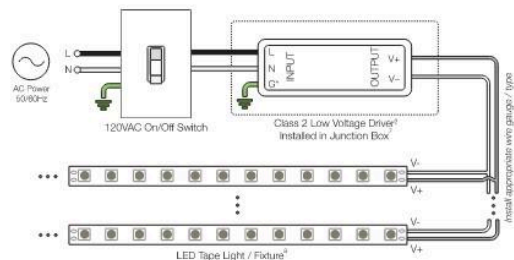

SWITCHEX® Dimmer/Driver System

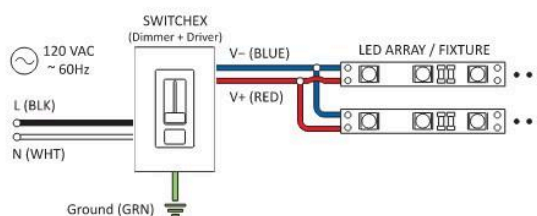

OMNIDRIVE® Electronic Dimmable Driver System

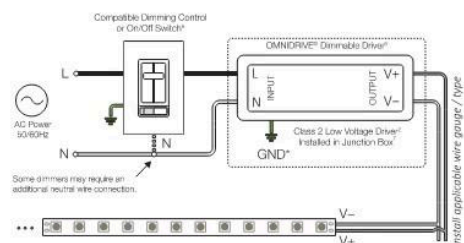

REIGN® 24V Dimmer System

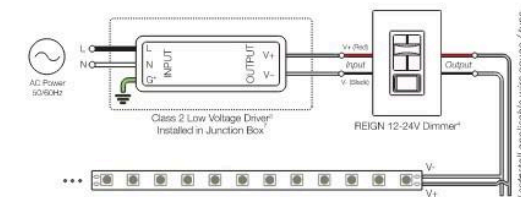

1. Driver may not require a fault ground connection. Refer to driver specifications for additional information.
2. Install a compatible Class 2 constant voltage driver. Refer to each driver specification sheet for full power ratings & load deratings.
3. Install a Class 2 constant voltage driver compatible with a low voltage PWM controller/dimmer switch. Refer to each driver specification sheet for full power ratings & load deratings.
4. Determine the number of low voltage outputs of the driver when installing multiple PWM controllers/dimmer switches. No more than one PWM controller/dimmer switch can be attached to a single output of the driver.
5. Install a compatible dimming control or switch. See the 'Electronic Dimmable Driver / Dimmer Compatibility List' for compatible dimming controls. See the dimming control manufacturer installation guide for complete wiring instructions.
6. Ensure to load the driver at least 60% of the labeled load for proper dimming performance (required for dimmable installations only).
7. Refer to driver or controller specifications for a compatible junction box.
8. See fixture specifications for maximum series run limits.



Toll Free: 877.817.6028 | Fax: 415.592.1596 | www.DiodeLED.com | info@DiodeLED.com
 © 2023 Elemental LED Inc. All rights reserved. Specifications are subject to change without notice.

Before you begin, read all warnings and installation instructions thoroughly.

Safety & Warnings

- Install in accordance with the National Electric Code, and local regulations.
- This product is intended to be installed and serviced by a qualified, licensed electrician.
- Only install compatible LED fixtures & controls. Only use copper wiring.
- Proper heat dissipation will prolong the working lifespan of this product. Install in a well-ventilated area free from explosive gases and vapors.
- Ensure applicable wire is installed between driver, fixture, and any controls in between. When choosing wire, factor in voltage drop, amperage rating, and type (in-wall rated, wet location rated, etc.). Inadequate wire installation could overheat wires, and cause a fire.
- Do not install if product has any visible damage.
- Do not modify or disassemble this product beyond instructions or the warranty will be void.

Quick Specs

Input Voltage	120-277VAC, 50/60Hz
Output Voltage	See driver label
Ambient Temperature †	-40°F ~ 140°F (-40°C ~ 60°C)
Minimum Load	None
Maximum Load	Refer to 'Derating Curve'

† Do not install product in an environment outside the listed ambient temperature.

Installation

Prior to installation, ensure all components are a compatible system. Configure and pre-test your LED system prior to permanent installation to ensure all components are operating correctly. Install in accordance with the NEC and local regulations.

- 1 Turn OFF High Voltage AC Power** at the main breaker.

⚠ WARNING Shock Hazard. May result in serious injury or death. Turn off power at circuit breaker before installing this product.

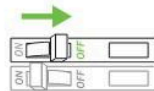

- 2 Determine Locations to Install 3 Main Components.** Refer to the 'System Diagrams.'



1) Compatible Control

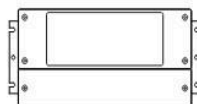

2) Driver



3) Fixture

Ensure applicable wire is installed between driver, fixture, and any controls in between. When choosing wire, factor in voltage drop, amperage rating, and type (in-wall rated, wet location rated, etc.).

- 3 Mount Driver to Surface.** See 'Wiring Connections' for mounting holes. **Driver may be mounted in any orientation.**

- 4 Attach Lighting Load and Control. Only use copper wiring.** Refer to 'Wiring Connections', 'System Diagrams', and dimming control installation guides. **Ensure to install a compatible dimming control** listed on the 'OMNIDRIVE® X Dimming Control Compatibility List' available at www.DiodeLED.com.

- When installing in ambient temperatures that may reach over 100°F, **refer to the 'Derating Curve' to avoid overheating and damage to the driver.**

DERATING CURVE

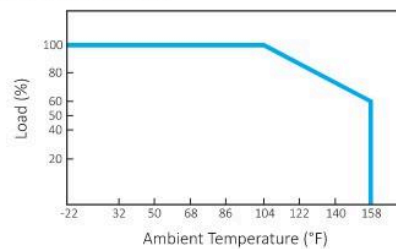

IG120423-4.0

4 Continued

- b. **All Models** - Use applicable UL Listed wire nuts and junction box to secure wire connections.
- c. **Do not install different fixture types on the same power supply** as flickering and altered dimming range may occur.

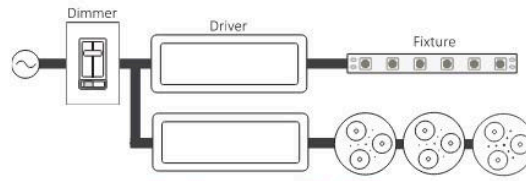
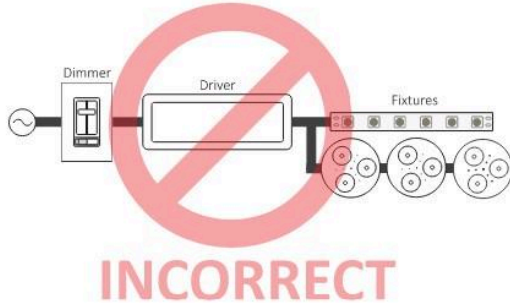

CORRECT

Different fixture types on separate drivers.

5 Install Additional Components, Verify connections, and Turn Main Power ON at Breaker.

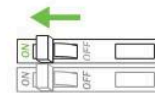

If system remains unresponsive or is working improperly, turn OFF main power at breaker and verify all connections. Review the 'Wiring Connections', 'System Diagrams', and dimming control installation guides.

Mechanical Diagram

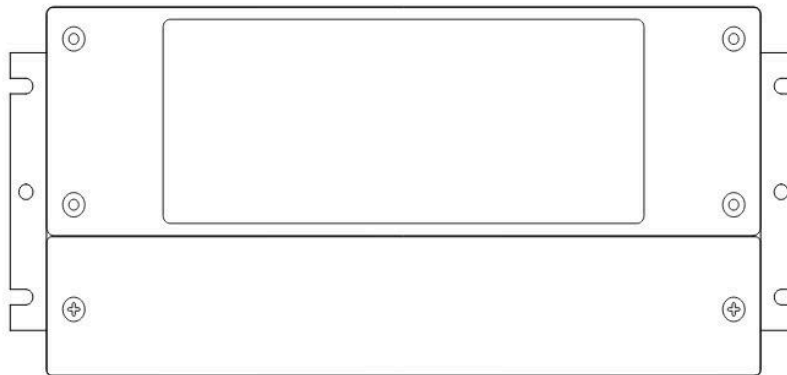

Wire caps must be removed from purple and pink wires for 0-10V installations.
Wire caps must remain on purple and pink wires for all other installations.

System Diagrams

The following diagrams are provided as example system designs. Always review each component installation guide for detailed and up-to-date wiring instructions. Install in accordance with NEC and local regulations.

OMNIDRIVE® X 2-Wire Dimming or ON/OFF Standard System Diagram

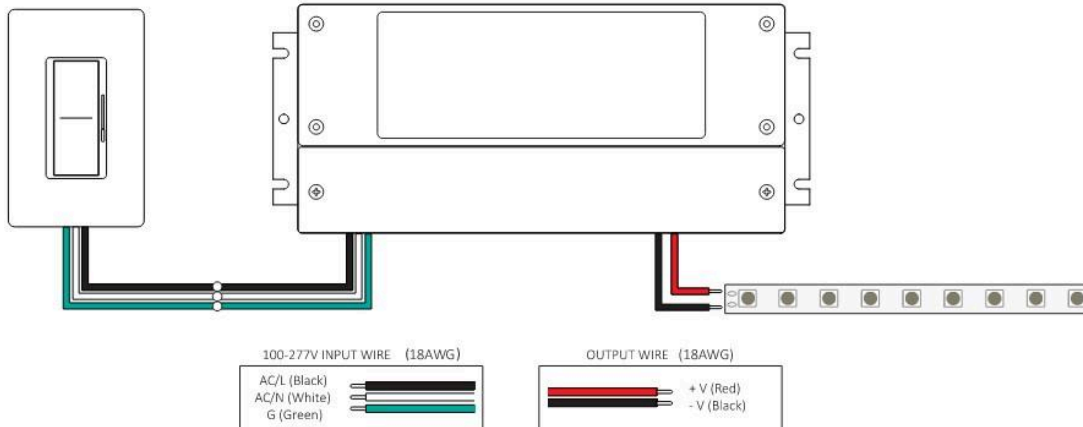

OMNIDRIVE® X 0-10V System Diagram (Dimmer with No Power Pack)

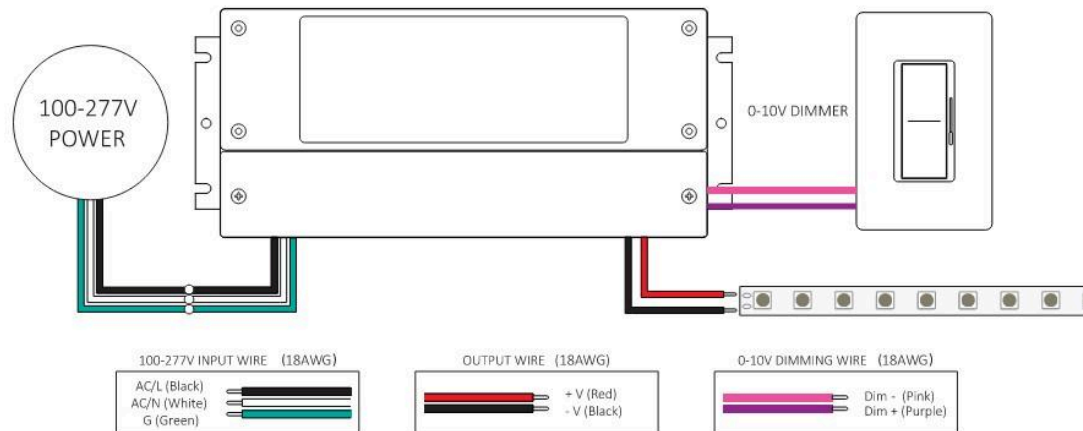

*If utilizing power pack, refer to third party manufacturer's Instruction Guide.

- * Driver may not require a framed ground connection. Refer to driver specifications for additional information. †† See fixture specifications for maximum series run limits.
- ^ Install a compatible dimming control or switch. See the 'Electronic Dimmable Driver / Dimmer Compatibility List' for compatible dimming controls. See the dimming control manufacturer installation guide for complete wiring instructions.

System Diagrams Cont'd

0-10V Dimmable Driver Large Install System Diagram (Example)

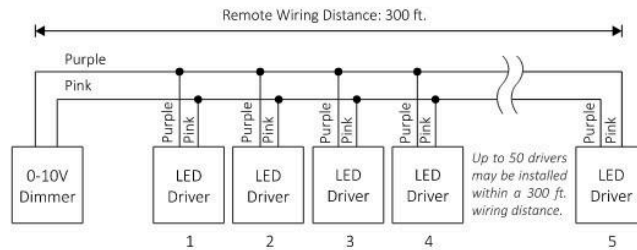

Troubleshooting

Fixture does not illuminate	<ul style="list-style-type: none"> See 'System Diagram', 'Wiring Connections' and installation guides of all components. Ensure the system is wired correctly and polarities are correct. Ensure a compatible constant voltage <i>dimmmable</i> fixture is installed. Ensure the driver and fixture have the same voltage specifications (12V & 12V, or 24V & 24V).
Fixture does not dim	<ul style="list-style-type: none"> Ensure a compatible constant voltage <i>dimmmable</i> fixture is installed. Ensure a compatible dimming control is installed and wired correctly. See 'OMNIDRIVE® X / Dimming Control Compatibility List'.
Different fixture types do not dim in sync	<ul style="list-style-type: none"> Different fixture types have different circuit designs and may react differently when dimmed. Ensure each fixture type is installed on a separate dimmable driver for best performance.
Fixture is quickly flashing or flickering	<ul style="list-style-type: none"> Verify a compatible dimming control is installed. If flickering is apparent at low light levels install a compatible trim-adjustable dimming control. Ensure a compatible constant voltage <i>dimmmable</i> fixture is installed. Ensure different fixture types are not connected to a single driver. Different fixture types must be connected to individual drivers. Ensure all connections are properly secured. Ensure fixture is receiving the correct input voltage.
Fixture is slowly flashing	<ul style="list-style-type: none"> Ensure driver is not overloaded. An overloaded driver will cause the internal auto-reset to trip repeatedly.
Installation Trips Main Breaker	<ul style="list-style-type: none"> Check wiring for short circuit. If breaker continues to trip there may be a short in the driver. Call customer support for a replacement driver.

Additional Resources

Visit the online product page at www.DiodeLED.com for additional product specifications & warranty information.

- **OMNIDRIVE® X Specification Sheet**
For full specifications.
- **OMNIDRIVE® X Dimming Control Compatibility List**
For compatible dimming controls.
- **Voltage Drop Charts**
Use to specify appropriate wire gauge for installation. Available at the 'Tools & Resources' page at www.DiodeLED.com.

QUESTIONS?

Visit www.DiodeLED.com or contact Customer Support at info@diodeled.com or 1.877.817.6028 Monday through Friday, 7:00am - 5:00pm PST.

IG120423-4.0